

PICKUP WIRE COLOR CODES

DiMarzio & EMG

- BLACK = FINISH = NORTH =
- RED = START = NORTH =
- WHITE = FINISH = SOUTH =
- GREEN = START = SOUTH =

Bare Knuckle

- BLACK = FINISH = NORTH
- WHITE = START = NORTH
- GREEN = FINISH = SOUTH
- RED = START = SOUTH

Seymour Duncan

- WHITE = FINISH = NORTH
- BLACK = START = NORTH
- RED = FINISH = SOUTH
- GREEN = START = SOUTH

Lace

- GREEN = FINISH = NORTH
- ORANGE = START = NORTH
- W/B = FINISH = SOUTH
- O/B = START = SOUTH

Schaller & Shadow

- YELLOW = FINISH = NORTH
- BROWN = START = NORTH
- GREEN = FINISH = SOUTH
- WHITE = START = SOUTH

Gibson

- WHITE = FINISH =
- BLACK = START =

DIMARZIO WIRE COLOR CODE

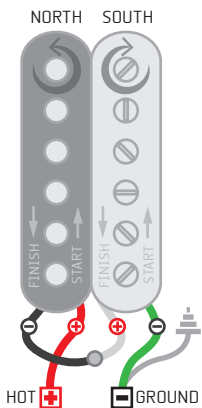

SERIES/OUT OF PHASE
(Most common)
F+F=SERIES LINKED
S+BRAID=GROUND LEAD
S=HOT LEAD

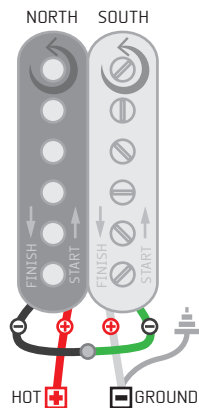

SERIES/IN PHASE
(No humbucking)
F+S=SERIES LINKED
F+BRAID=GROUND LEAD
S=HOT LEAD

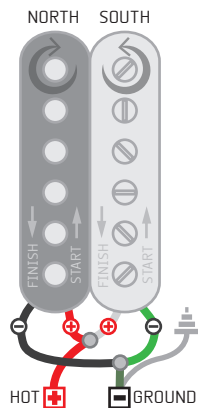

PARARELL/OUT OF PHASE
(Humbucking w/single coil sound)
F+S+BRAID=GROUND LEAD
F+S=HOT LEAD

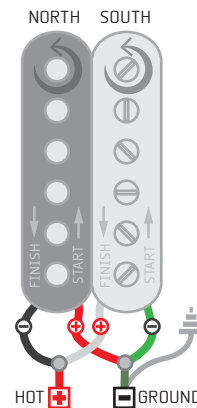

PARARELL/IN PHASE
(No humbucking)
S+S+BRAID=GROUND LEAD
F+F=HOT LEAD

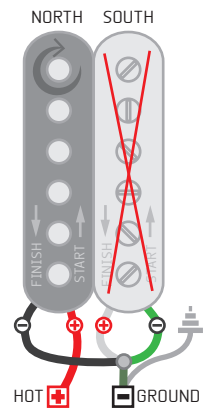

COIL CUT
(Ground out, 1 coil, No humbucking)
F+F+S+BRAID=GROUND LEAD
S=HOT LEAD

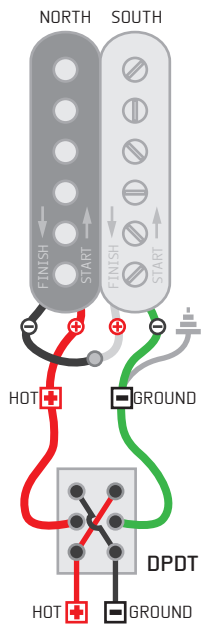

PICKUPS OUT OF PHASE
(Only need ONE switch on ONE pickup)

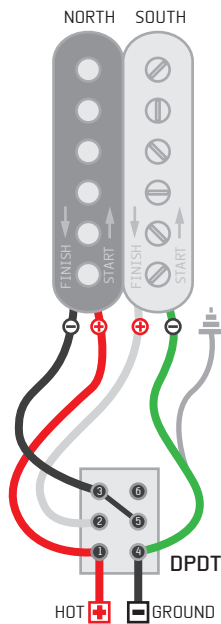

DUAL SOUND
(Switch between Serial & Parallel sounds)

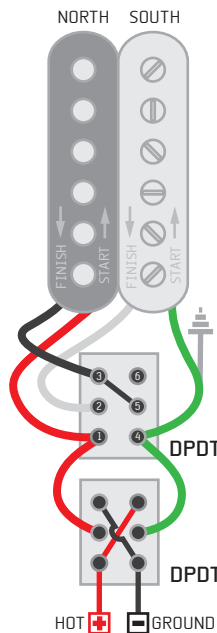

DUAL SOUND & PHASE SWITCH
(Switch between Serial & Parallel sounds)

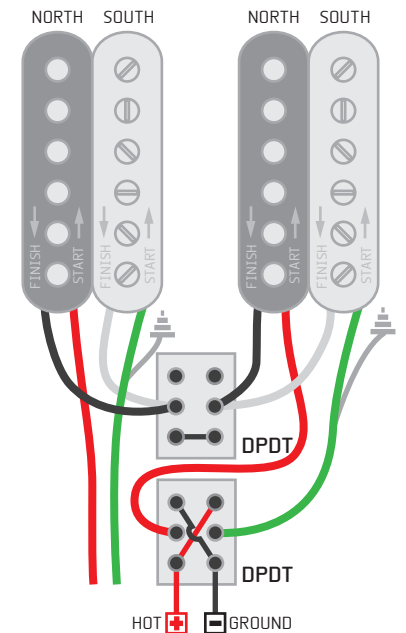

SINGEL COIL & PHASE SWITCH
(Switch between Humbucking & single Coil + phase switch)